

LHS 21: Designed for professionals.

These advanced air heaters are distinguished by their extremely small dimensions – especially the lean design (only 67 mm wide) – as well as their long service life. Designed for professional integration into machine systems, the new LHS series enables any specific application. Sterilizing, drying, welding, cleaning, shrinking, shaping, deburring and activating are now more efficient and reliable thanks to Leister's proven hot-air technology!

Air heater LHS 21



Technical data LHS 21S / 21L

Max. air outlet temperature	°C	650
Max. air inlet temperature	°C	65
Max. ambient temperature	°C	65
Min. air flow		As per diagram page 29
Max. inlet pressure	kPa	100
Weight 21S / 21L	kg	0.55 / 0.65

Conformity mark	CE
Approval mark	Ⓢ
Protection class II	□

Installation dimensions in mm

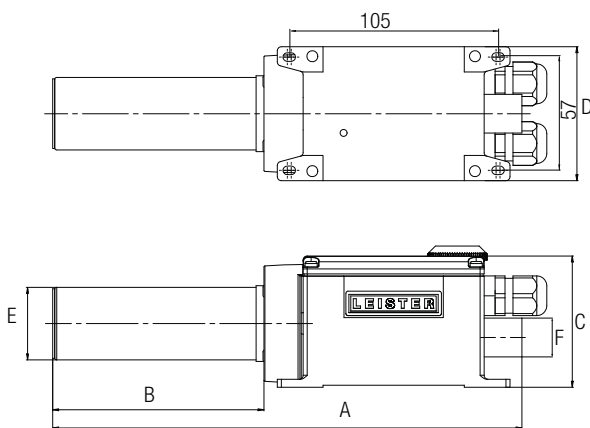

Type	A	B	C	D	E	F
LHS 21S	236	106	66	67	⌀ 36.5	⌀ 19.5 G 3/8"
LHS 21L	266	136	66	67	⌀ 36.5	⌀ 19.5 G 3/8"

Combination possibilities

- Leister air heater at maximum heat power and without nozzle with Leister blower at 50 Hz, 1.5 m hose length and unimpeded air outflow.
- Hot-air temperature 3 mm after air outlet, measured at the hottest point.
- Air flow at 0°C, 101.3 kPa compliant with DIN 1343.

Power Typ	Number LHS 21S x power cons. kW	LHS 21S x Air flow l/min.	LHS 21S Temperature °C
ROBUST	1 × 1.0	1 × 640	160
ROBUST	2 × 1.0	2 × 420	200
ROBUST	4 × 1.0	4 × 240	300
ROBUST	1 × 2.0	1 × 590	300
ROBUST	2 × 2.0	2 × 390	380
ROBUST	4 × 2.0	4 × 220	540
MONO	2 × 1.0	2 × 341	236
MONO	1 × 2.0	1 × 525	333
MONO	2 × 2.0	2 × 353	450

Power Typ	Number LHS 21L x power cons. kW	LHS 21L x Air flow l/min.	LHS 21L Temperature °C
ROBUST	1 × 3.3	1 × 550	520
ROBUST	2 × 3.3	2 × 390	610
AIRPACK	2 × 3.3	2 × 1210	270
AIRPACK	4 × 3.3	4 × 700	340

Air flow and temperature values may deviate from those above based on the design of the entire hot-air system (including nozzles, air hoses, environmental conditions).

High-end air heaters on an indexing table for producing light bulbs.



Air heater

LHS 21 CLASSIC



Heating power not adjustable

Detection of heating element and device overheating with alarm output

Air heater

LHS 21 PREMIUM



Heating power steplessly adjustable with potentiometer

Protection against heating element and device overheating with alarm output

Air heater

LHS 21 SYSTEM



Heating power or temperature steplessly adjustable with potentiometer or remote control interface

Protection against heating element and device overheating with alarm output

Remote control interface for external temperature controllers (Leister CSS, or PLCs)

Air Heaters
Controllers

Order No.:		CLASSIC	PREMIUM	SYSTEM
LHS 21S	1.0 kW/120V	139.868	140.454	140.458
LHS 21S	1.0 kW/230V	139.869	140.455	140.459
LHS 21S	2.0 kW/120V	139.870	140.456	140.460
LHS 21S	2.0 kW/230V	139.871	139.909	139.910
LHS 21L	3.3 kW/230V	139.872	140.457	140.461

Contact a Leister sales partner in your region for professional advice and information on our other air heaters and blowers.

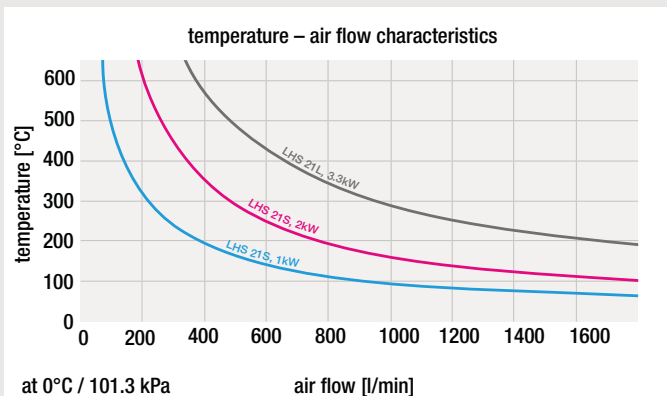





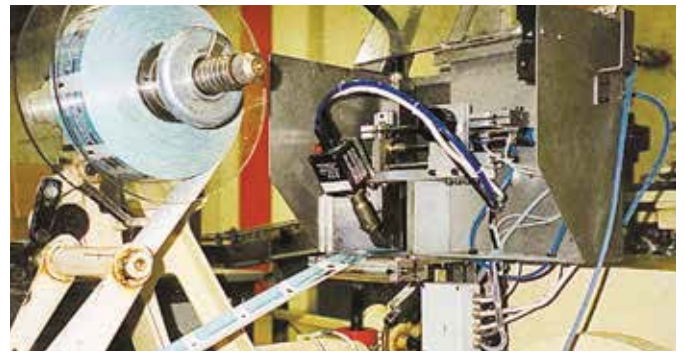

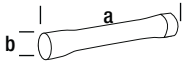

Accessories 40

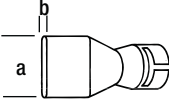
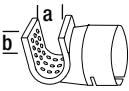
Air heater and blower for drying labels. Fast drying allows for high throughput speeds.

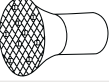
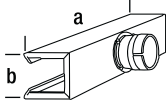

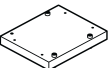
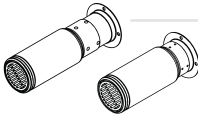
Accessories LHS 21 (Ø 36.5 mm)

	125.316 Flange connector, push-fit a = 62 mm
	107.251 Extension nozzle, push-fit (a × b) 210 × 36.5 mm
	107.003 Round nozzle, push-fit Ø 12 mm
	Wide slot nozzle, push-fit (a × b) 107.261 70 × 4 mm 108.078 100 × 4 mm 105.982 150 × 4 mm
	Sieve reflector, push-fit (a × b) 107.308 35 × 50 mm 107.309 20 × 35 mm
	107.314 Spoon reflector, push-fit (a × b) 25 × 30 mm
	107.319 Sieve reflector «Douche», push-fit Ø 65 mm
	106.132 Shell reflector, push-fit (a × b) 150 × 25 mm
	133.515 Thermocouple holder
	144.037 Compressed air connection
	Adapter plate 142.230 LHS 21 instead LHS 20 143.480 LHS 21 instead LE 3000
	150.194 Heater tube (Ø 36.5) with protection tube for LHS 21L 150.193 Heater tube (Ø 36.5) with protection tube for LHS 21S
	149.942 Round nozzle (Ø 36.5) for LHS 21
	150.098 Air inlet reduction valve for LHS 21